







GENERAL SAFETY PRECAUTIONS

9.5XP



As you read these instructions, you will see WARNINGS, CAUTIONS, NOTICES and NOTES. Each message has a specific purpose. WARNINGS are safety messages that indicate a potentially hazardous situation, which, if not avoided could result in serious injury. CAUTIONS are safety messages that indicate a potentially hazardous situation which, if not avoided, may result in minor or moderate injury. A CAUTION may also be used to alert against unsafe practice. CAUTIONS and WARNINGS identify the hazard, indicate how to avoid hazard, and advise of the probable consequence of not avoiding the hazard. NOTICES are messages to avoid property damage. NOTES are additional information to help you complete a procedure. **PLEASE WORK SAFELY!**

 WARNING		
		
<p>MOVING PARTS ENTANGLEMENT HAZARD Failure to observe these instructions could lead to severe injury or death.</p> <p>To avoid injury to hands or fingers.</p> <ul style="list-style-type: none"> • Always keep hands clear of wire rope, hook loop, hook and fairlead opening during installation, operation, and when spooling in or out. • Always use extreme caution when handling hook and wire rope during spooling operations. • Always use supplied hook strap whenever spooling wire rope in or out, during installation or operation to avoid injury to hands or fingers. 		

 WARNING	
	
<p>CHEMICAL AND FIRE HAZARD Failure to observe these instructions could lead to severe injury or death.</p> <ul style="list-style-type: none"> • Always remove jewelry and wear eye protection. • Never lean over battery while making connections. • Always verify area when drilling is clear of fuel lines, fuel tank, brake lines, electrical wires, etc • Never route electrical cables: <ul style="list-style-type: none"> - Across any sharp edges. - Through or near moving parts. - Near parts that become hot. • Always insulate and protect all exposed wiring and electrical terminals. • Always install terminal boots as directed in installation instructions. 	

 WARNING	
	
<p>FALLING OR CRUSHING HAZARD Failure to observe these instructions could lead to severe injury or death.</p> <ul style="list-style-type: none"> • Never use as an overhead hoist, or to suspend a load. • Never use to lift or move persons. 	

CAUTION

MOVING PARTS ENTANGLEMENT HAZARD
Failure to observe these instructions could lead to minor or moderate injury.

General Safety:

- **Always** Know Your Winch: Take time to fully read and understand the included Installation and Operations guide, and Basic Guide to Winching Techniques, in order to understand your winch and the winching operation.
- **Never** operate this winch if you are under 16 years of age.
- **Never** operate this winch when under the influence of drugs, alcohol or medication.
- **Never** exceed winch or wire rope rated capacity. Double line using a snatch block to reduce winch load.

Installation Safety:

- **Always** choose a mounting location that is sufficiently strong to withstand the maximum pulling capacity of your winch.
- **Always** use factory approved switches, remote controls, accessories and installation components.
- **Always** use grade 5 or better hardware, never weld bolts and never use longer bolts than those supplied from factory.
- **Always** complete winch mounting and attachment of hook to hook loop before wiring winch during installation.
- **Always** position fairlead with WARNING label on top.
- **Always** spool the wire rope onto the drum as indicated by the drum rotation label on the winch. Required for automatic brake to work (if winch is so equipped) and for correct installation orientation.
- **Always** prestretch wire rope and respool under load before use. Tightly wound wire rope reduces chances of "binding", which is wire rope working it's way down into a loosely wound wire rope layer, and catching or damaging itself.

CAUTION

MOVING PARTS ENTANGLEMENT HAZARD
Failure to observe these instructions could lead to minor or moderate injury.

Winching Safety:

- **Always** inspect winch installation and wire rope condition before operating winch. Frayed, kinked or damaged wire rope must be replaced immediately. Loose or damaged winch installation must be corrected immediately.
- **Never** leave remote control plugged into winch while free spooling, rigging, or sitting idle.
- **Never** hook wire rope back onto itself. This damages the wire rope. Always use a choker chain, wire choker rope or tree trunk protector on the anchor.
- **Always** prior to winching, remove any element that may interfere with safe winch operation.
- **Always** take your time when rigging for a winch pull.
- **Always** be certain the anchor you select will withstand the load, and the strap or chain will not slip.
- **Never** engage or disengage clutch if winch is under load, wire rope is in tension or wire rope drum is moving.
- **Always** unspool as much wire rope as possible when rigging. Double line or pick distant anchor point.
- **Never** winch with less than 5 wraps of wire rope around the drum, the wire rope could come loose from the drum.
- **Always** stand clear of wire rope and load during operation.
- **Never** touch wire rope or hook while in tension or under load.
- **Never** touch wire rope or hook while someone else is at the control switch or during winching operation.
- **Never** touch wire rope or hook while remote control is plugged into winch.
- **Always** stand clear of wire rope and load and keep others away while winching.

 **CAUTION**

MOVING PARTS ENTANGLEMENT HAZARD
Failure to observe these instructions could lead to minor or moderate injury.

Winching Safety:



- **Always** require operator and bystanders to be aware of stability during winching of vehicle and/or load.
- **Always** keep remote control lead clear of the drum, wire rope and rigging. Inspect for cracks, pinches, frayed wires or loose connections. Replace if damaged.
- **Always** pass remote control through a window to avoid pinching lead in door, when using remote inside a vehicle.

NOTICE

AVOID WINCH AND EQUIPMENT DAMAGE

- **Always** avoid continuous side pulls which can pile up wire rope at one end of the drum. This can damage your wire rope or winch.
- **Always** ensure the clutch is fully engaged or disengaged.
- **Never** use winch to tow other vehicles. Shock loads can momentarily exceed capacity of wire rope and winch.
- **Always** use care to not damage your frame when anchoring your vehicle during a winching operation.
- **Always** "jog" wire rope under load. Shock loads can momentarily exceed capacity of wire rope and winch.
- **Never** use winch to secure a load during transport.
- **Never** submerge winch in water.
- **Always** store the remote control in a protected, clean, dry area.

 **CAUTION**

CUT AND BURN HAZARD
Failure to observe these instructions could lead to minor or moderate injury.

To avoid injury to hands or fingers:

- **Always** wear heavy leather gloves when handling a wire rope.
- **Never** let wire rope slip through your hands.

To avoid injury to hands or fingers:

- **Always** be aware of possible hot surface at winch motor, drum or wire rope during or after winch use.

9.5xp

9.5xp INSTALLATION INSTRUCTIONS

Winch Mounting

- Choose a mounting location that is sufficiently strong enough to withstand the loads you intend to winch.
- **Find the diagrams of your winch on the following pages. Refer to them for proper orientation.** Only the mounting orientation shown is possible for safe winching operation. All others are improper and inappropriate.
- **Feet Forward Mounting:**
When mounting winch with feet forward, removal of sealant from the drain slot at **LOWER** position is required. Sealant should then be placed into the drain slot at the **UPPER** position. Refer to Winch Mounting diagram.
- The wire rope must always spool onto the drum as indicated by the drum rotation decal.
- The use of recommended bolt and lock washer combinations torqued to recommended levels will prevent vibration during operation.
Find the diagrams of your winch on the following pages. Refer to them for proper torque levels.

WARNING

- To avoid serious injury or death from electrical fire:
- **Never route electrical cables:**
 - Across any sharp edges.
 - Through or near moving parts.
 - Near parts that become hot.
 - **Always insulate and protect all exposed wiring and electrical terminals.**
 - **Always install terminal boots as directed in installation instructions.**



Electrical Connections

- Make sure to use the insulating boots on the exposed connections to prevent electrical shorting. Route battery connection cables in areas which will not cause them to chafe or cut through the insulation causing a potential short circuit.
- Upon completion of installation, check winch for proper operation.

Refer to the electrical circuit diagram below and the diagrams for your winch on the following pages.

ELECTRICAL CIRCUIT DIAGRAM

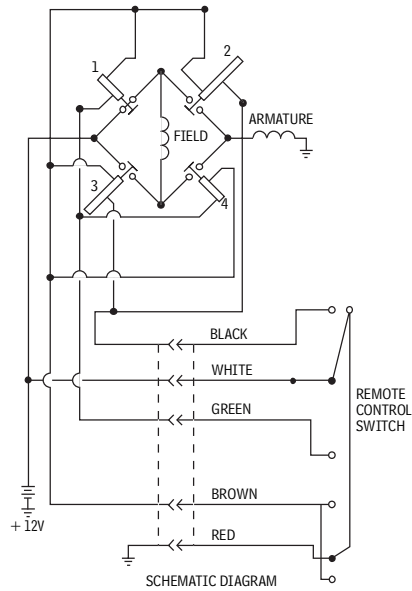

Solenoid Pack Installation

- Mount the control pack according to the instructions included in the WARN mounting system kit. Use the bracket included in the kit.
- To mount the control pack directly to the winch, order control pack bracket part number 26368.
- The control pack mounting fasteners may also be moved to the unused holes in the control pack base plate for additional mounting flexibility.

9.5xp WINCH MOUNTING **9.5xp**

Mounting location:

- (1) Smooth and flat, thickness = 1/4" (6.4 mm)
- (2) 3/8" (9.525 mm) lockwasher X 4
- (3) 3/8-16 X 1 1/4" long, grade 5 bolt X 4
torque 30-35 ft. lbs. (41-47Nm)

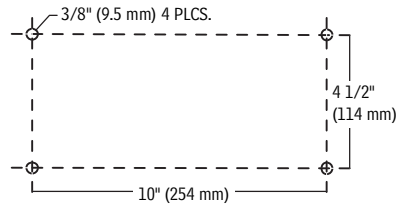

Mounting bolt pattern:

10.0" x 4.5", 254mm x 114.3mm

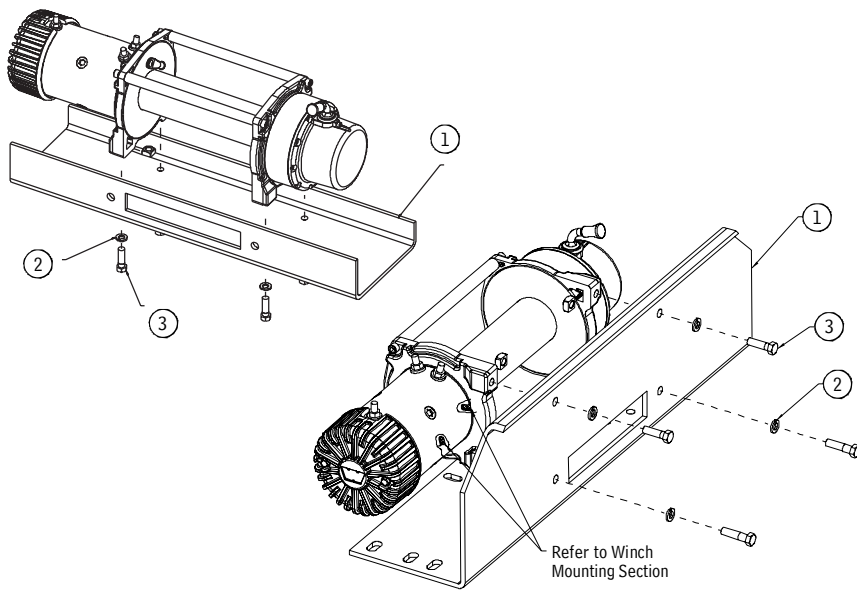

9.5xp ELECTRICAL CONNECTIONS

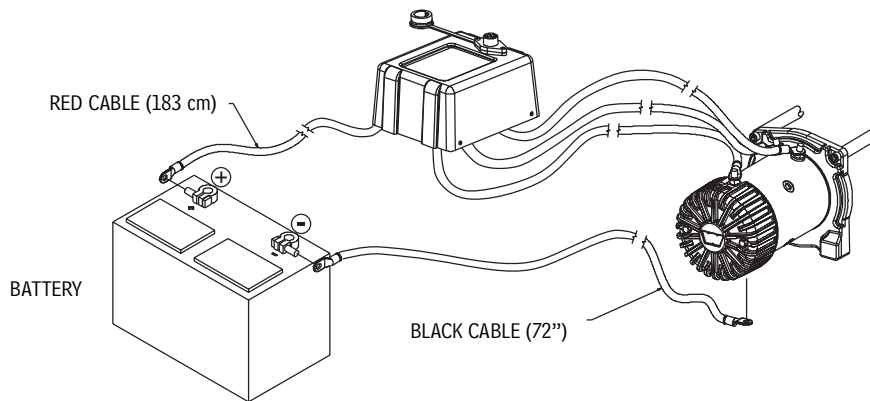

9.5xp

9.5xp OPERATING INSTRUCTIONS

CAUTION

ALWAYS KNOW YOUR WINCH: Take time to fully read and understand the included Installation and Operations guide, and Basic Guide to Winching Techniques, in order to understand your winch and the winching operation.

REMOTE CONTROL SWITCH

Do not leave the remote plugged into the winch when not in use. Leaving the remote plugged in, may result in a dangerous condition and/or battery drain.

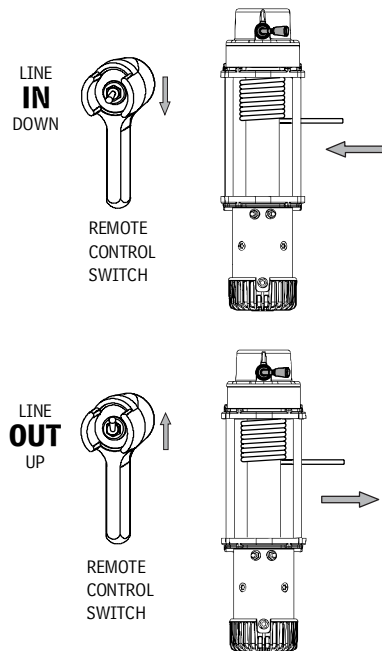

CLUTCH OPERATION

When the clutch is engaged the gear train is coupled to the wire rope drum and power may be transferred from the winch motor. When the clutch is in free spool the gear train and wire rope drum are uncoupled allowing the drum to rotate freely. The clutch knob, located on the winch housing opposite the motor, controls the clutch position. To prevent damage, always fully engage or fully disengage the clutch knob.

CAUTION

To avoid minor or moderate injury:

- Never engage or disengage clutch if winch is under load, wire rope is in tension or wire rope drum is moving.

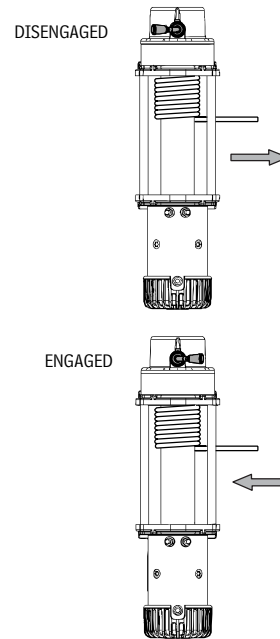

OVERLOADING/OVERHEATING

This winch is rated for intermittent duty. When the motor approaches stall speed, very rapid heat buildup occurs which may cause motor damage.

Double-line rigging (see Rigging section) will reduce the amperage draw, and reduce heat buildup in the motor. This allows longer continual use.

CLEANING

- Do not direct high pressure water (pressure washers, car washes, etc.) directly between the drum support and drum flange or clutch lever.
- Use low pressure water and a soapy rag or sponge to clean the winch.
- Avoid using chemicals that may damage the finish.
- Thoroughly clean salt residue from the winch as soon as possible to minimize corrosion.

BATTERY RECOMMENDATIONS

A fully charged battery and good connections are essential to the proper operation of your winch. The minimum requirement for a 12 volt DC battery is 650 Cold Cranking Amperes.

MAINTENANCE

- No lubrication is required for the life of the winch, unless the winch is submerged in water. If this occurs, a qualified service center must complete service as soon as possible to prevent corrosion damage. If the control pack is submerged, it must be replaced when the winch is serviced.
- Check battery cables and electrical connections at 90 day intervals to be certain they are clean and tight at all connection points.
- Inspect the wire rope before and after each winching operation. When damaged, replace with the size specified in the Replacement Parts List.
- The wire rope must always spool onto the drum as indicated by the drum rotation decal on the winch.

WINCHING**CAUTION**

To avoid minor or moderate injury:

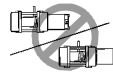

- Always wear heavy leather gloves when handling a wire rope.
- Never winch with less than 5 wraps of wire rope around the drum, the wire rope could come loose from the drum.

OPERATOR'S SAFE WORKING STATIONS

The operator should always operate the winch in a safe position while pulling a load. The safe areas are perpendicular to the wire rope or in the vehicle with the hood up (if winch is mounted on front of vehicle). This will help prevent the wire rope from striking the operator if it fails under load. Operate the winch, when possible, at the end of the remote control length. The operator must be at least 8 ft (2.44m) from the winch while operating. This will prevent entanglement with the fairlead and keep the operator out of harms way during winch load pulling.

Never work around wire rope while under load.

9.5xp

9.5xp OPERATING INSTRUCTIONS

SPOOLING



To prevent severe injury or death:



- Always keep hands clear of wire rope, hook loop, hook and fairlead opening during installation, operation, and when spooling in or out.
- Always use extreme caution when handling hook and wire rope during spooling operations.
- Always use supplied hook strap whenever spooling wire rope in or out, during installation or operation to avoid injury to hands or fingers.

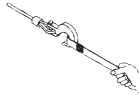

STRETCHING WIRE ROPE

- The life of a wire rope is directly related to the use and care it receives. During its first use, a new wire rope must be spooled onto its drum under a load of at least 500 lb. [227 kg]. Spool out the wire rope to the last 5 wraps on the drum, then power in the wire rope under a load of 500 lb. [227 kg] or more. This will stretch new wire rope and create a good wire wrap around the drum. Failure to do so will result in the outer wire wraps drawing into the inner wraps, binding, and damaging the wire rope.

SPOOLING OUT

- Freespooling is generally the quickest and easiest way to spool out wire rope. Before freespooling wire rope out from the winch, power out enough rope to remove any tension the wire rope may be under. Disengage the clutch. Now freespool by manually spooling out enough wire rope for the winching operation. Always leave at least 5 wraps on the drum.

SPOOLING IN UNDER LOAD

- Never exceed winch's rated line pull.
- Power in the wire rope evenly and tightly on the drum. This prevents the outer wire wraps from drawing into the inner wraps, binding, and damaging the wire rope.
- Avoid shock loads when spooling, by using the control switch intermittently to take up wire rope slack. Shock loads can momentarily far exceed the winch and wire rope ratings.

SPOOLING IN UNDER NO LOAD

- Assisted - Have your assistant hold the hook with the hook strap putting as much constant tension on the wire rope as possible. While keeping tension, the assistant should walk toward the winch while you operate the control switch spooling in the wire rope. **Release the switch when the hook is a minimum of 8 ft [2.44 m] from the fairlead opening.** Spool in the remainder for storage.
- Unassisted - Arrange the wire rope to be spooled so it will not kink or tangle when spooled. Be sure any wire rope on the drum is tightly and evenly layered. Spool enough wire rope to complete the next full layer on the drum. **Tighten and straighten the layer. Repeat process until the hook is a minimum of 8 ft [2.44 m] from the fairlead opening.** Spool in the remainder for storage.

SPOOLING REMAINDER FOR STORAGE

- Secure the hook to a suitable anchor point near the winch. Carefully power in the remaining wire rope, joggling the control switch to take up the last of the slack. Be careful not to over tighten or damage may occur to the wire rope or anchor point.

SOUND EMISSIONS

- The winch is designed so that the sound emissions do not exceed 70 dBA from the operator's station. The operator must be at least 8 ft. (2.44m) from the winch while operating. If the winch is exceeding 70 dBA from the operator's station, have it inspected at an authorized service center.

RIGGING

CAUTION

To avoid minor or moderate injury:



- Always stand clear of wire rope and load during operation.
- Never hook wire rope back onto itself. This damages the wire rope. Always use a choker chain, wire choker rope or tree trunk protector on the anchor.
- Always prior to winching, remove any element that may interfere with safe winch operation.
- Always take your time when rigging for a winch pull.
- Always be certain the anchor you select will withstand the load, and the strap or chain will not slip.

- Always spool out as much wire rope as possible while leaving the last 5 wraps on the drum. Pick an anchor as far away as practical. This provides the winch with its greatest pulling power.

- Approximate pulling power:

Pulling Power	Wire Rope Layer
9500 lb. (4310 kg)	1st layer*
8650 lb. (3924 kg)	2nd layer
7920 lb. (3593 kg)	3rd layer
7400 lb. (3357 kg)	4th layer
6940 lb. (3148 kg)	5th layer

*closest to drum core

- Rigging a double line with a snatch block will reduce the load on the winch in half without significant loss of spooling speed.
- Natural anchors such as trees, stumps and rocks are the handiest when available. Attach the choker chain, wire choker rope or tree trunk protector on the anchor as low as possible to avoid pulling the anchor down. If several possible anchors are available but they are not strong enough individually, it may be practical to attach a wire or chain choker around several anchors to form a strong collective anchor point.
- Some of the most commonly used riggings are shown at right:

Single Line Pull

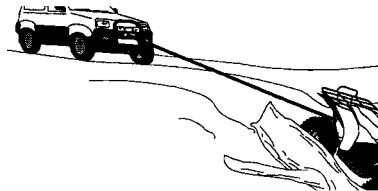

Double Line

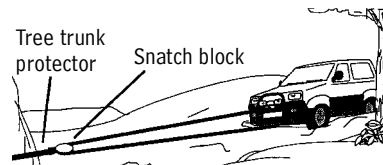

Direction Change

